

SITTTZ

AMBIENTE SEU AMBIENTE

INDEX

OPERATIVO	07
EXECUTIVO	15
POLTRONA	41
COLABORATIVO	55
MULTIFUNCIONAL	81

INDEX



08 Grand

OPERATIVO



16 Time
22 Airys
28 Fit
34 Andy

EXECUTIVO



42 Flow
48 Quadry

POLTRONA

COLABORATIVO

Flow Mod 56
Flow Talk 62
Woma 68
Honey 74



MULTIFUNCIONAL

Alpha 82
Kyos High 88



OPERATIVO

SITTZ

GRAND





GRAND

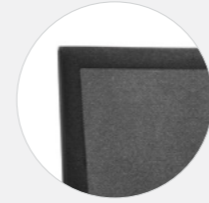

1. Encosto em tela dupla frontura que permite troca térmica.

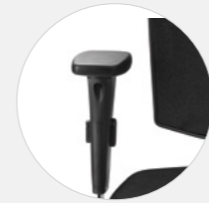

3. Braço com ajuste de altura em múltiplos pontos e apoia em PU.



5. Base em Nylon ou Alumínio com design piramidal.



2. Sistema Up Down: regulagem de apoio lombar para encosto.



4. Mecanismo Sincron com 4 estágios de parada e sistema de tensão auto ajustável.



6. Rodízio em PU ou Nylon.

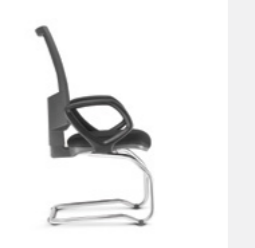

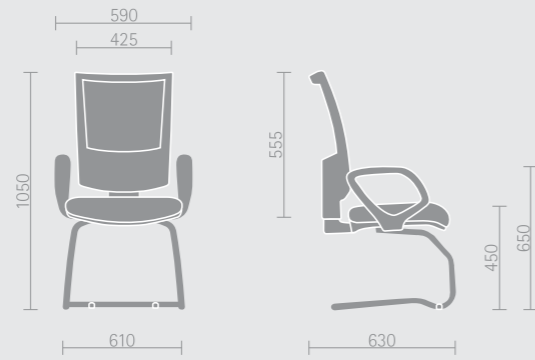

BASE



Basepiramidal-Alumínio



Base piramidal - Nylon

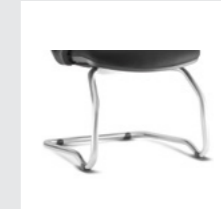

Estrutura fixa - Cromada



Estrutura fixa - Preta

MECANISMO



Mecanismo Sincron

BRAÇO



Braçocomregulagem-PP



Braçocomregulagem-PP



Braçocomregulagem-PP



Braço - PU

RODÍZIO



Rodízio - Nylon



Rodízio - PU

EXECUTIVO

The logo for SITIZ, featuring the word "SITIZ" in a bold, sans-serif font. The letter "Z" is highlighted in a light green color, while the other letters are in a dark grey or black color.



TIME

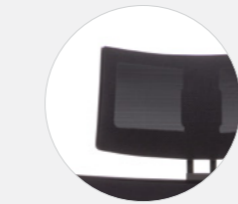

1. Encosto de cabeça articulado, elaborado em Polipropileno e tela.

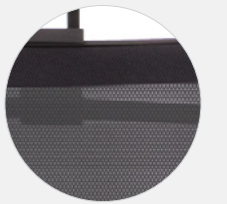

2. Porta paletó agregado ao encosto.

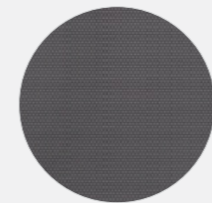

3. Encosto em tela que permite troca térmica. Opções de cores: preto, vermelho e cinza.

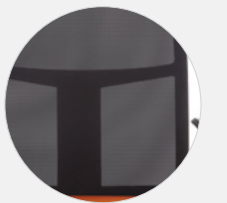

4. Sistema Up Down: regulagem de apoio lombar para encosto.



5. Braço com ajuste de altura em múltiplos pontos, em Polipropileno.



6. Mecanismo Syncron com 4 estágios de parada e sistema de tensão auto ajustável.



7. Base em Nylon ou Alumínio com design piramidal.

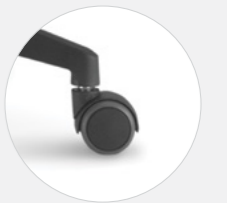

8. Rodízio em PU ou Nylon.

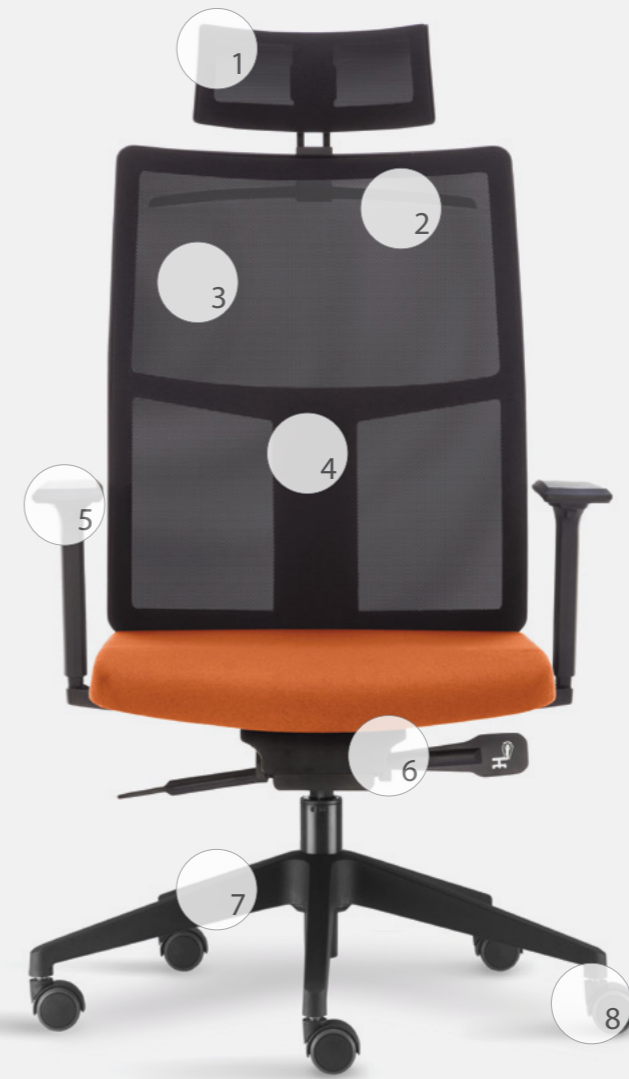

Time

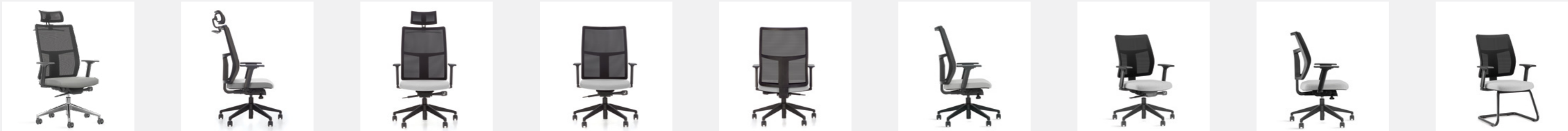
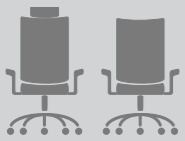

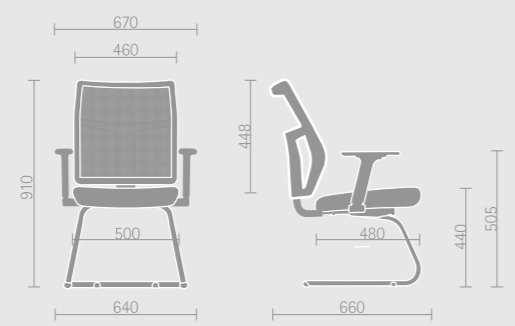
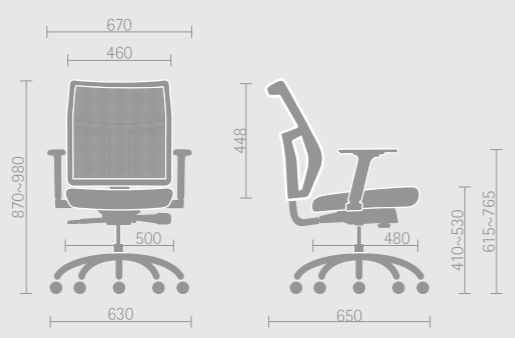
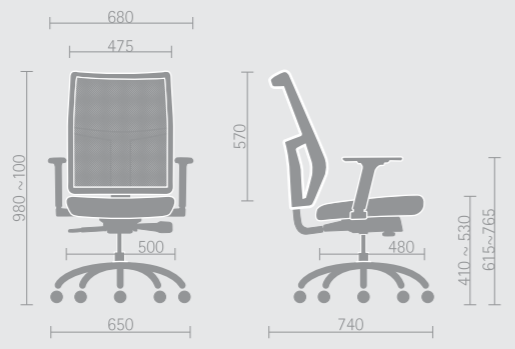
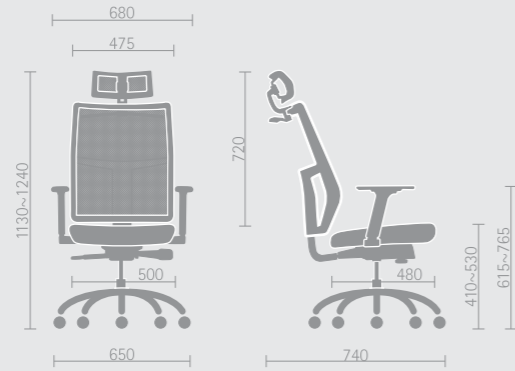

BASE			
	Base piramidal-Alumínio	Base piramidal - Nylon	
MECANISMO			
	Mecanismo Sincron-Auto		
BRAÇO			
	Braço com regulagem		
RODÍZIO			
	Rodízio - Nylon	Rodízio - PU	
	Flange simples	Mec. contato permanente	
	Base piramidal - Nylon	Base metálica com capa PP	Base arcada - Nylon

AIRYS



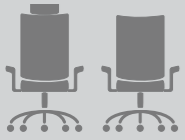

AIRYS

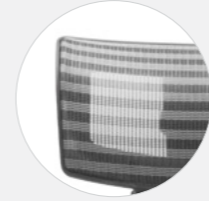

1. Encosto de cabeça articulado, elaborado em PP com tela ou estofado.

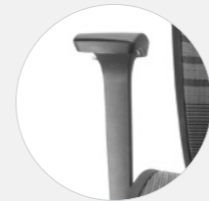

3. Braço com regulagem de altura em múltiplos e deslizamento do apoio em PU.



5. Assento em tela ou estofado.



7. Base em Nylon com design piramidal.

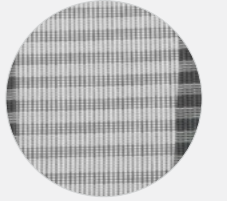

2. Encosto e assento em tela, que permite troca térmica.

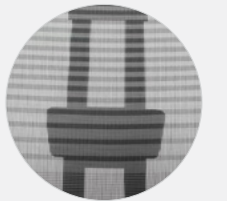

4. Ajuste lombar para o encosto.



6. Mecanismo Sincron de múltiplos pontos de parada, que permite deslizamento do assento, regulagem da profundidade e ajuste de tensão.



8. Rodízio em PU ou Nylon.

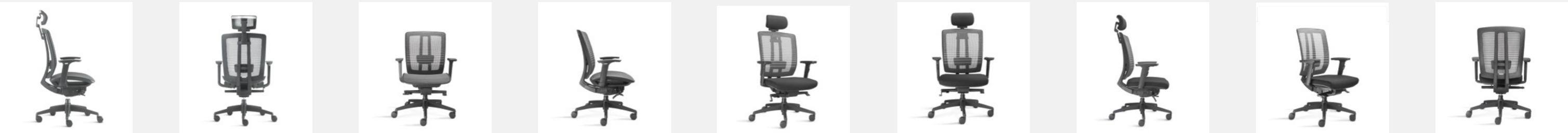

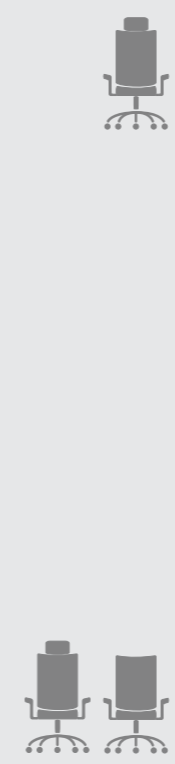

APOIO		
ASSENTO		
MECANISMO		
BRAÇO		
BASE		



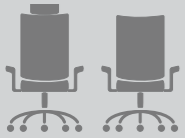

FIT

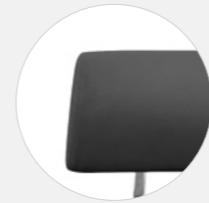

1. Encosto de cabeça tapeçado articulado.



3. Braço com regulagem de altura em múltiplos pontos e apoio com ajuste angular em PU.

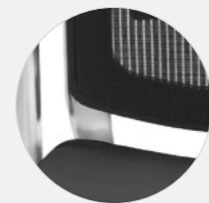

5. Suporte de fixação do encosto, em alumínio.



7. Rodízio em Nylon.

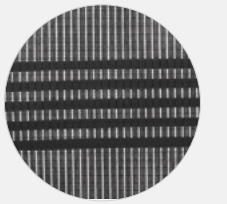

2. Encosto em tela com ajuste lombar, ou estofado sem ajuste.

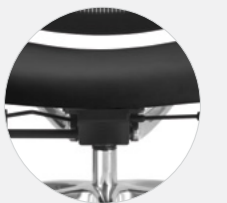

4. Mecanismo Sincron com múltiplos pontos de parada, deslizamento de assento, regulagem da profundidade e ajuste de tensão.



6. Base arcada em alumínio

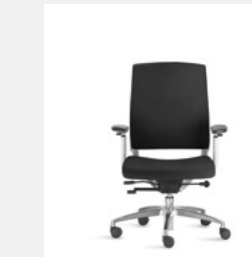
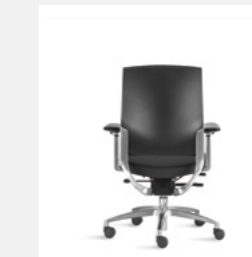
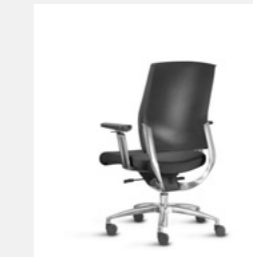
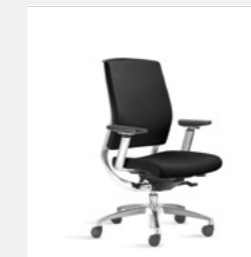
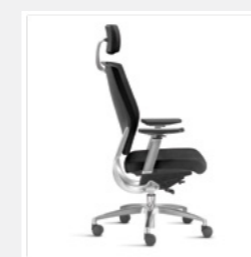
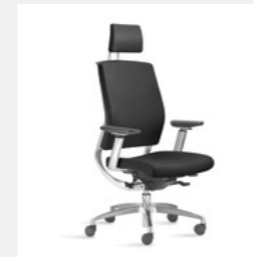
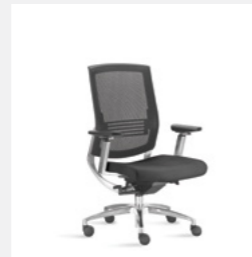



APOIO

Opção quando é Tela

Opção quando é Revestida

ENCOSTO

Encosto em Tela

Encosto Revestido

MECANISMO

Mecanismo

BRAÇO

Braço para PO

BASE

Base em Alumínio

ANDY





ANDY

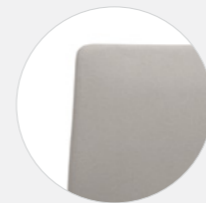

1. Encosto e assento em espuma injetada em PU com acabamento.



2. Sistema Up Down: regulagem de apoio lombar para encosto.



3. Braço com ajuste de altura em múltiplos pontos e apoio em PU.



4. Mecanismo Synchron, anti-impacto, com vários pontos de parada, regulagem de tensão manual ou automática e opção de ajuste da profundidade do assento.



5. Base em Nylon ou Alumínio com design piramidal.



6. Rodízio em PU ou Nylon.



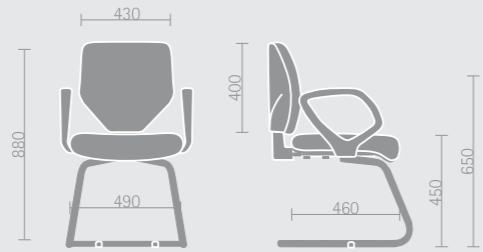

BASE



Base piramidal - Alumínio



Base piramidal - Nylon

MECANISMO



Mecanismo Sycron



Mecanismo Sycron-Auto



Mecanismo Deslizante

BASE



Base piramidal - Nylon



Base arcada - Nylon



Estrutura fixa - Preta

BRAÇO



Braço em PU

BRAÇO



Braço com regulagem-PP



Braço com regulagem-PP



Braço com regulagem-PP

RODÍZIO



Rodízio - Nylon



Rodízio - PU

POLTRONA

The logo for SITIZ, featuring the word "SITIZ" in a bold, sans-serif font. The letter "Z" is highlighted in a light green color, while the other letters are in a dark grey color.



FLOW

POLTRONA

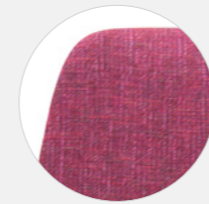

1. Concha em espuma injetada de alta densidade, com percintas elásticas.

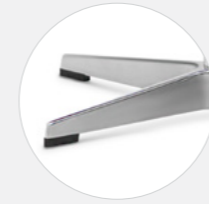

3. Base fixa em alumínio polido.



2. Mecanismo Oscilante, que permite movimento de inclinação da concha e giratório.

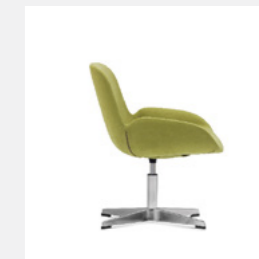
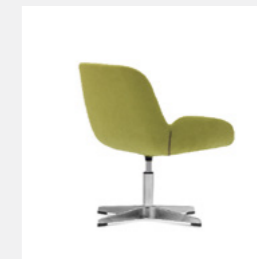
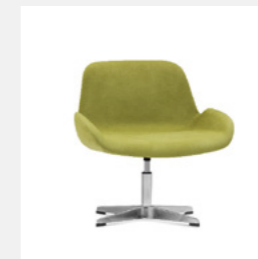
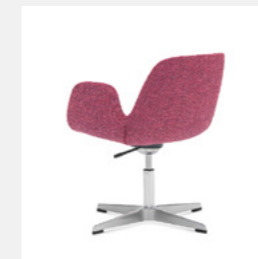
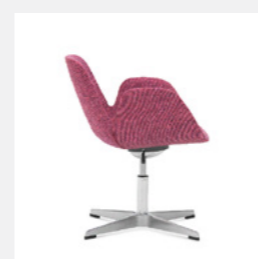
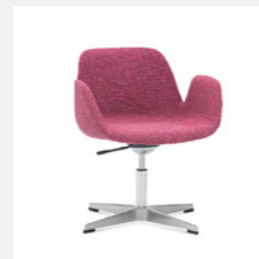
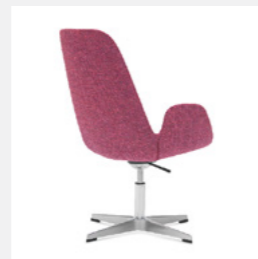
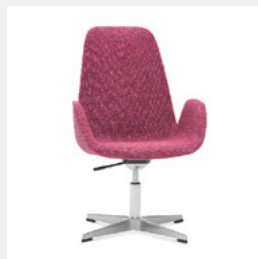

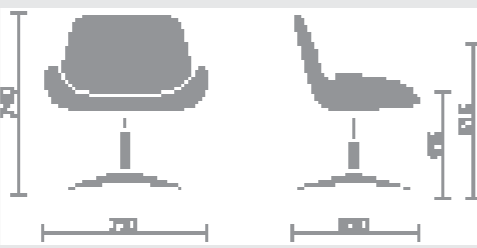
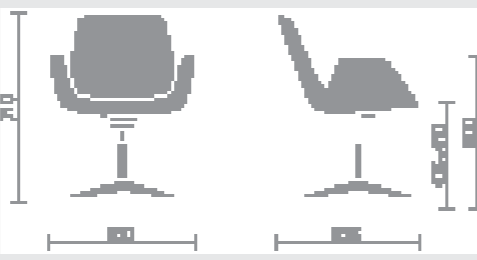



QUADRY

POLTRONA



QUADRY



1. Encosto em espuma injetada com percintas elásticas e revestido.

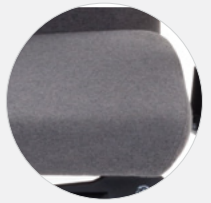

2. Assento em espuma injetada revestida.

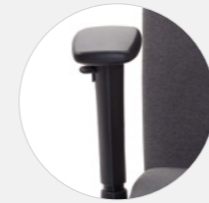

3. Braço com ajuste de altura em múltiplos pontos e apoio em PU.



4. Mecanismo Synchron com 4 estágios de parada e sistema de tensão autoajustável.



5. Base em Nylon ou Alumínio com design piramidal.



6. Rodízio em PU ou Nylon.

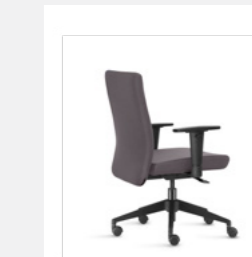
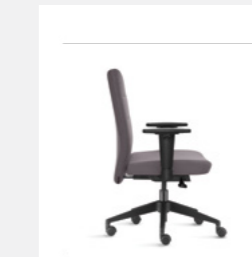
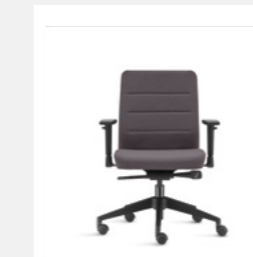
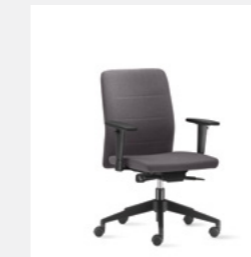
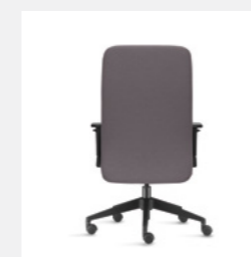
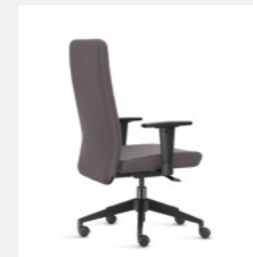
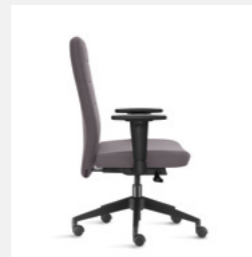

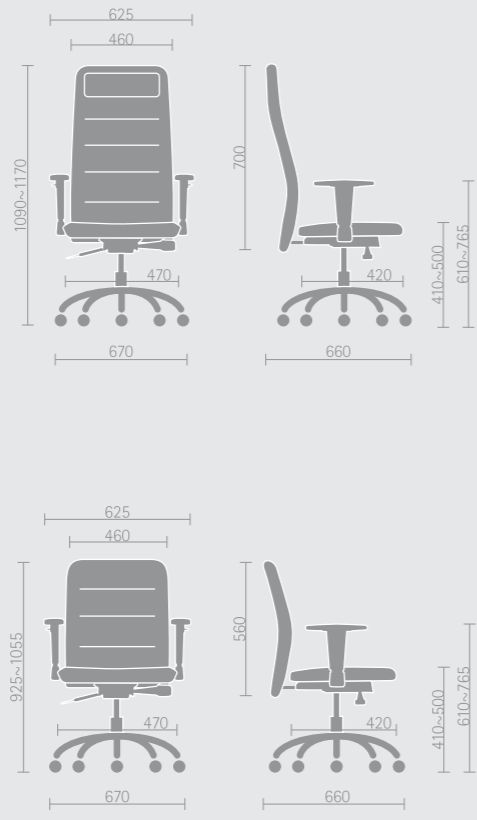

BASE		
	Base piramidal-Alumínio	Base piramidal - Nylon
MECANISMO		
	Mecanismo Sincron-auto	Mecanismo Deslizante
BRAÇO		
	Braço com regulagem-PP	Braço com regulagem-PP
RODÍZIO		
	Rodízio - Nylon	Rodízio - PU

COLABORATIVO

SITZ



FLOW MOD

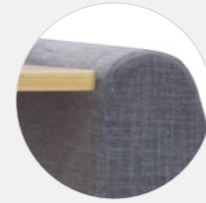

1 . Encosto anatômico em espuma de alta densidade.

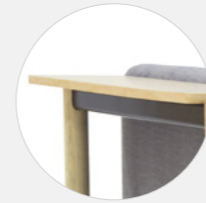

3. Mesa de apoio com tampo em madeira natural.



5. Pés em madeira natural com encaixe para suporte da estrutura.



2. Assento anatômico em espuma de alta densidade.



4 . Suporte metálico de sustentação e fixação dos pés.

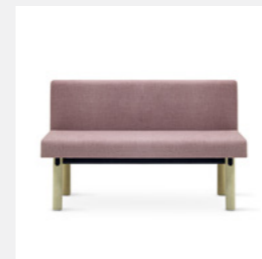
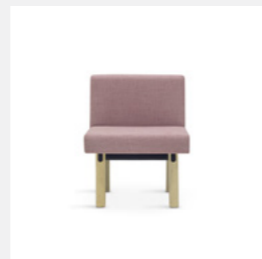
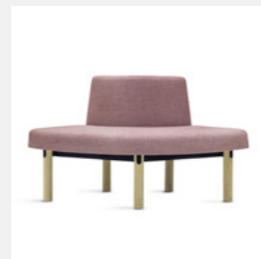
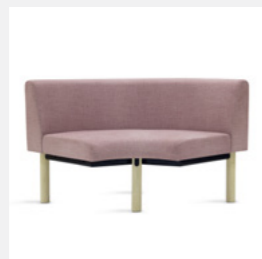

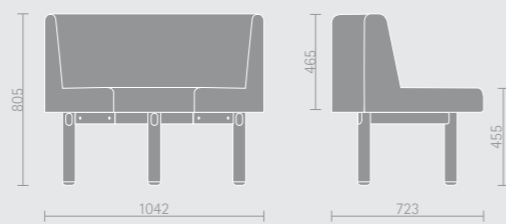
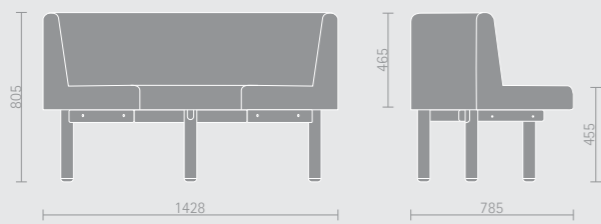
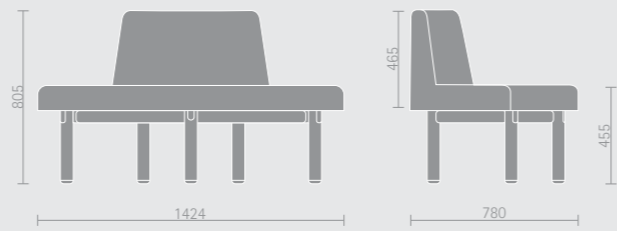
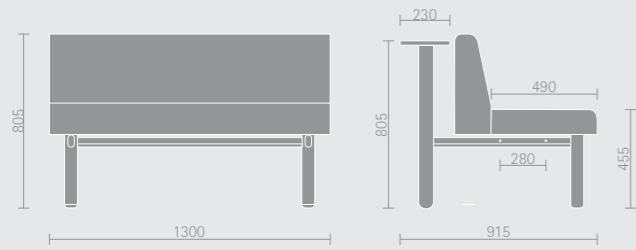
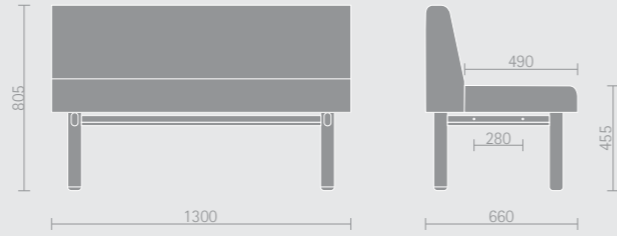
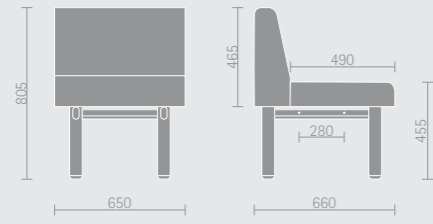

FLOW TALK



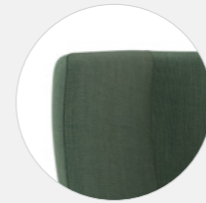

1 . Encosto anatômico em espuma de alta densidade.

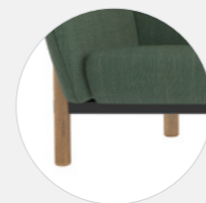

3. Pés em madeira natural com encaixe para suporte da estrutura.



2. Assento anatômico em espuma de alta densidade.

FLOW TALK

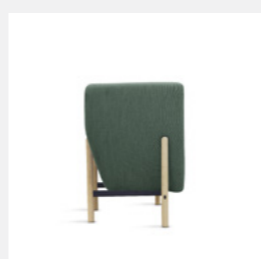
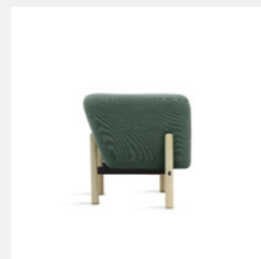
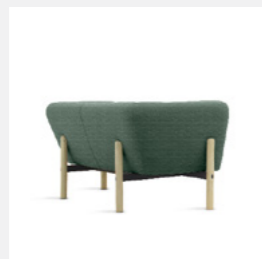

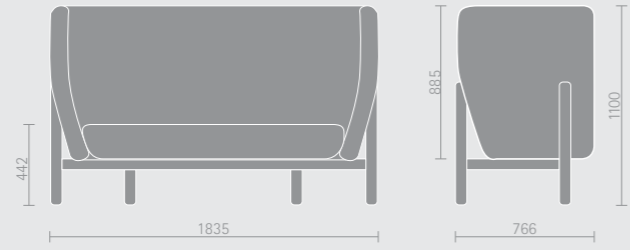





WOMA



1. Concha em espuma injetada e revestida, com percintas que permitem maior conforto.



3. Base fixa em alumínio.

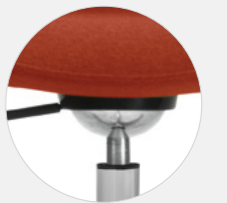

2. Mecanismo Oscilante, que permite movimento de inclinação da concha e giratório.

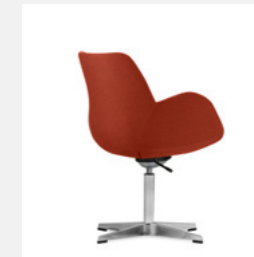
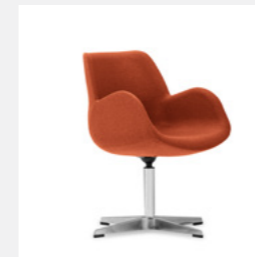
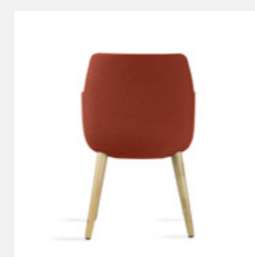
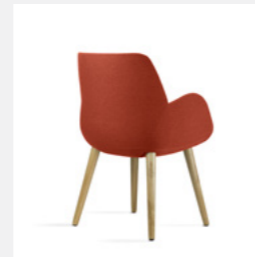

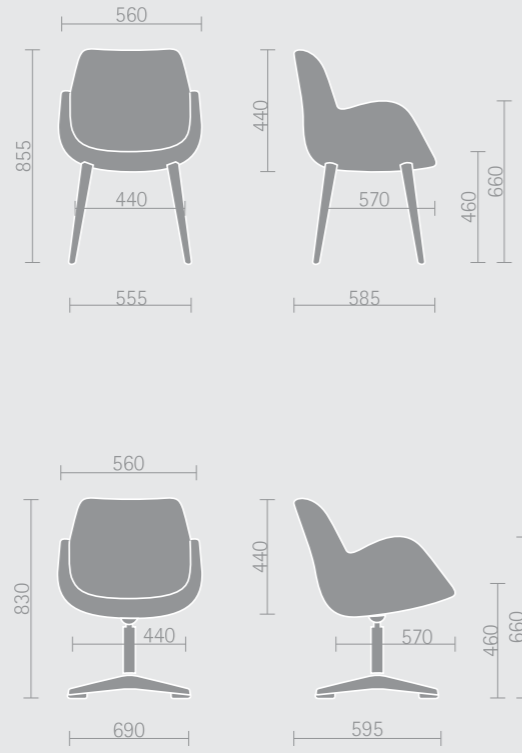

BASE

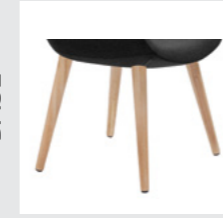

Pés - Madeira

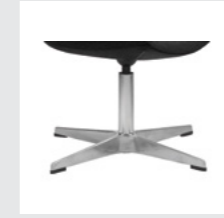

Base - Alumínio

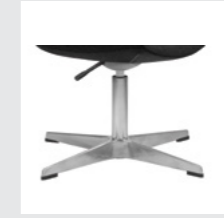

Base-Alumíniocomflange

HONEY



HONEY



1. Estrutura interna em madeira com espuma e revestimento.

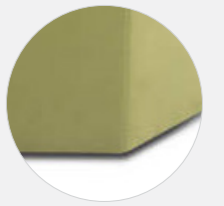
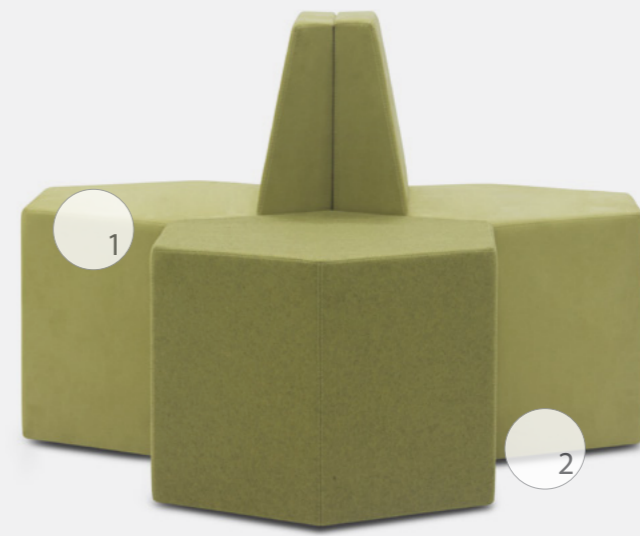

2. Sapatas fixa em PU incolor.



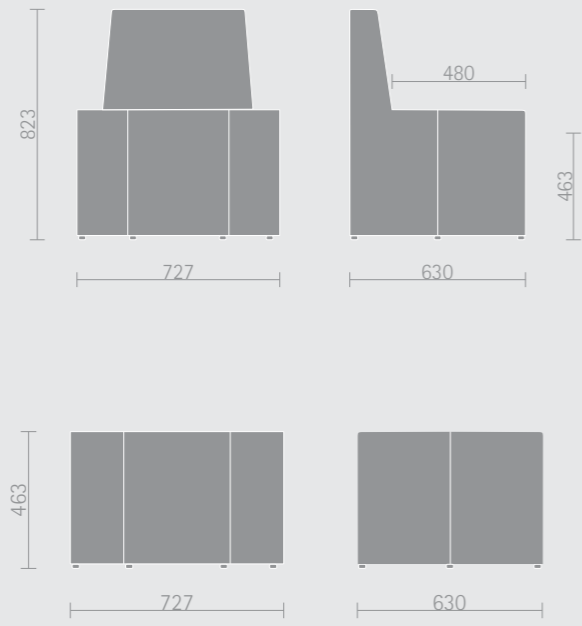

MULTIFUNCIONAL

SITTZ

LOVE

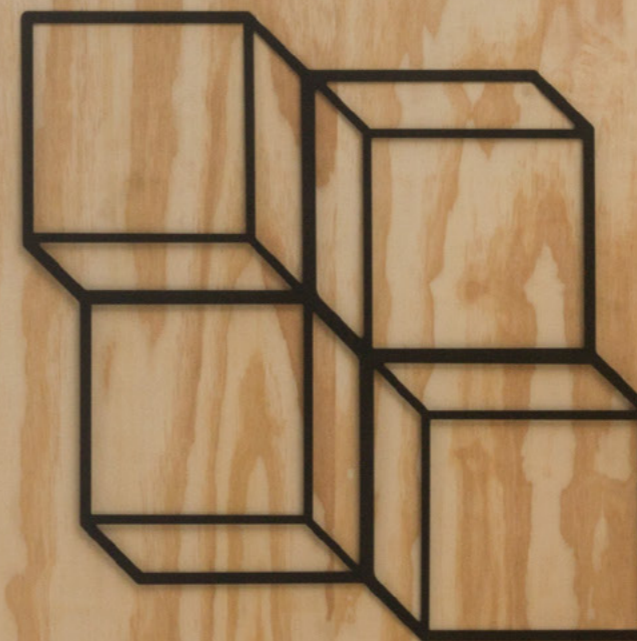

ALPHA



ALPHA

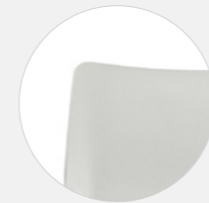

1. Encosto anatômico em PP.

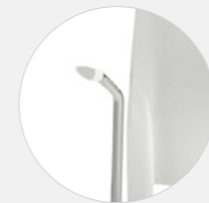

3. Braços cromados com apóias em PP.

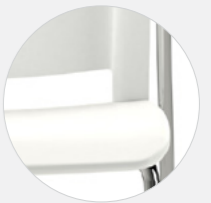

2. Assento anatômico com contracapa em PP.

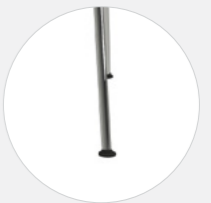

4. Pés cromados ou com pintura eletrostática a pó.

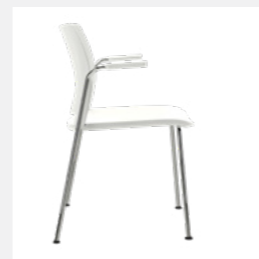
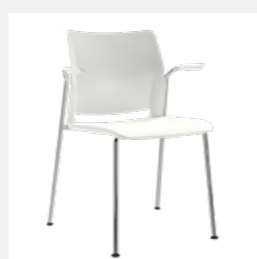
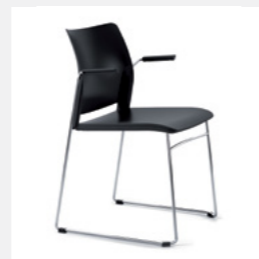
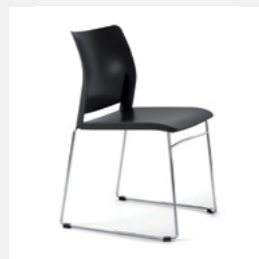
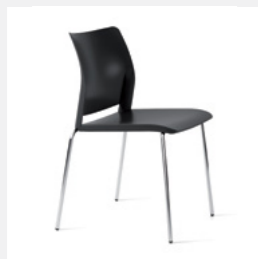

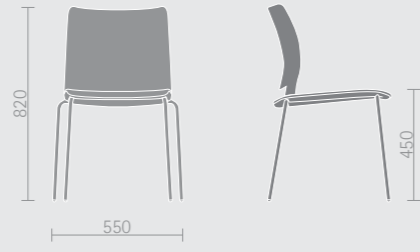
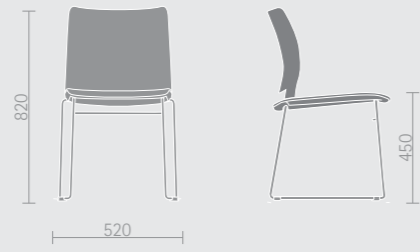

KYOS HIGH



LOVE

KYOS HIGH

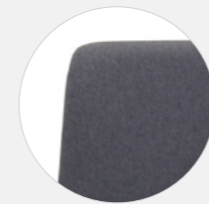

1. Encosto em espuma injetada em PU com tela, que permite troca térmica.

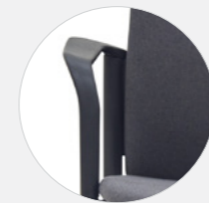

3. Braços em Polipropileno.



2. Assento em espuma injetada, com contracapa em PP.



4. Estrutura fixa 4 pés cromada ou com pintura eletrostática a pó.

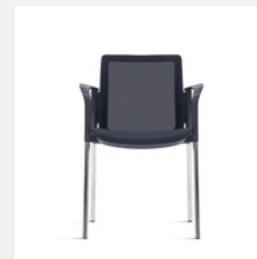
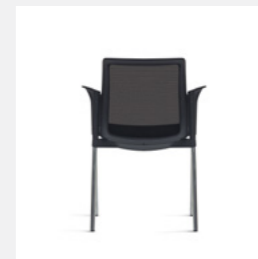
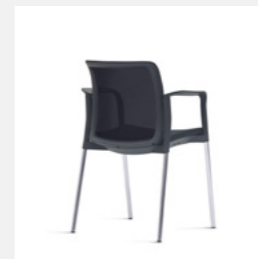
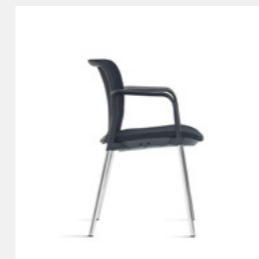
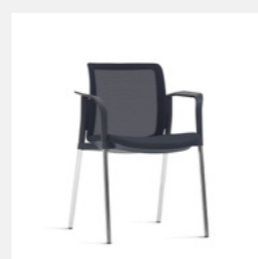
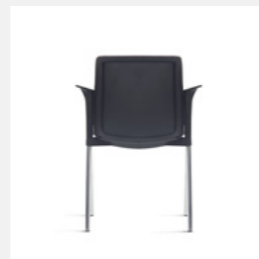
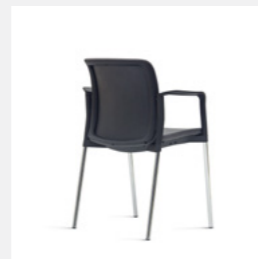
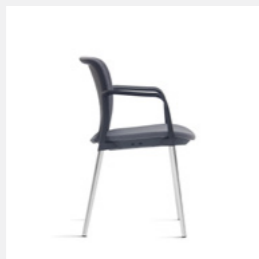

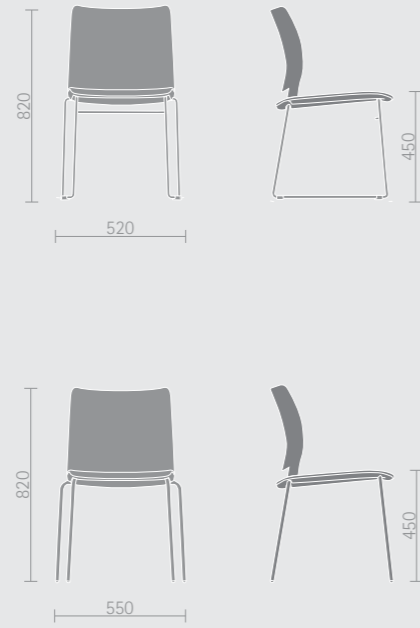

ENCOSTO

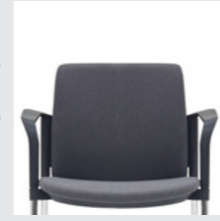

Encosto - Tapeçado

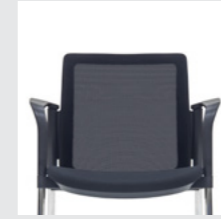

Encosto - m Tela

ESTRUTURA

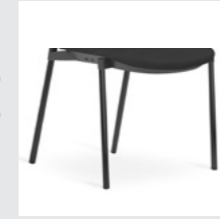

Estrutura - Preta

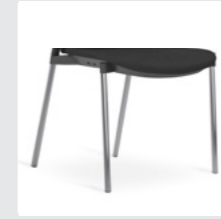

Estrutura - Cromada

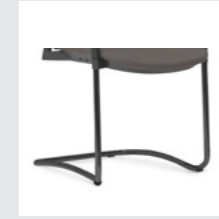

Estrutura - Preta



Estrutura - Cromada

BRAÇOS

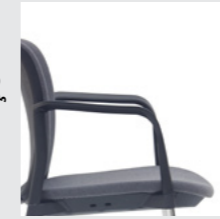

Braços

POLYESTER

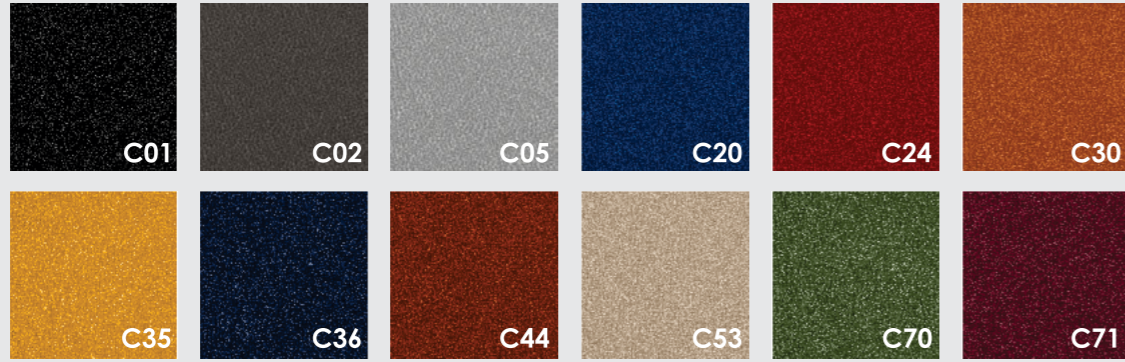

SINTÉTICO

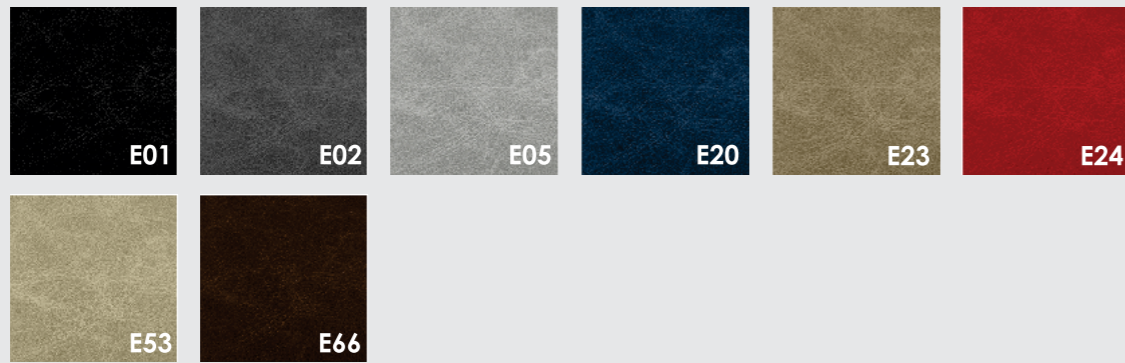

LÃ
Exclusivo para linha Home Office

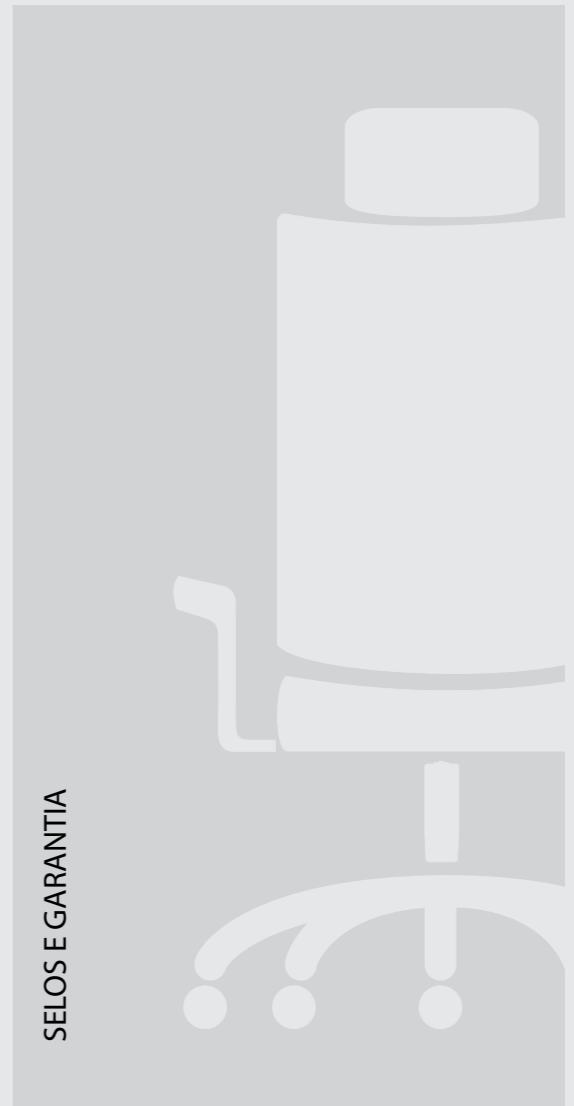

SELOS E GARANTIA

SITZ

contato@sitz.com.br
www.sitz.com.br